

VISTA B

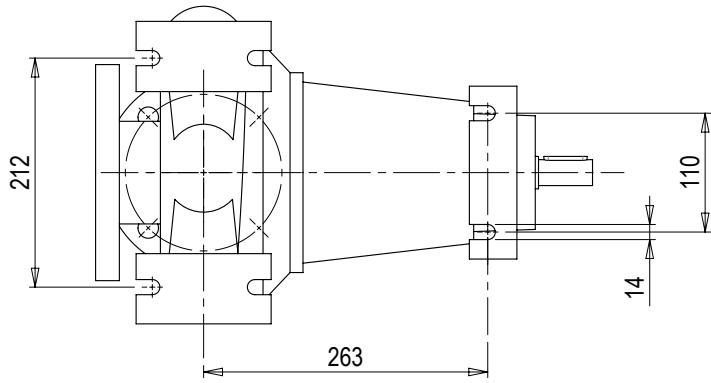

SEZ. A-A
SCALA: 1:1

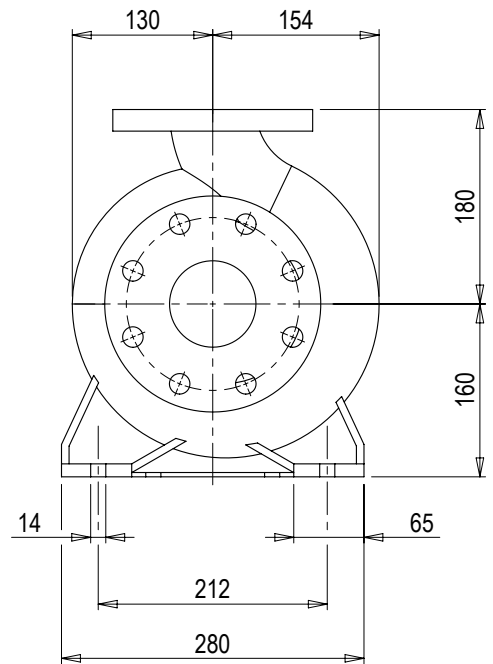
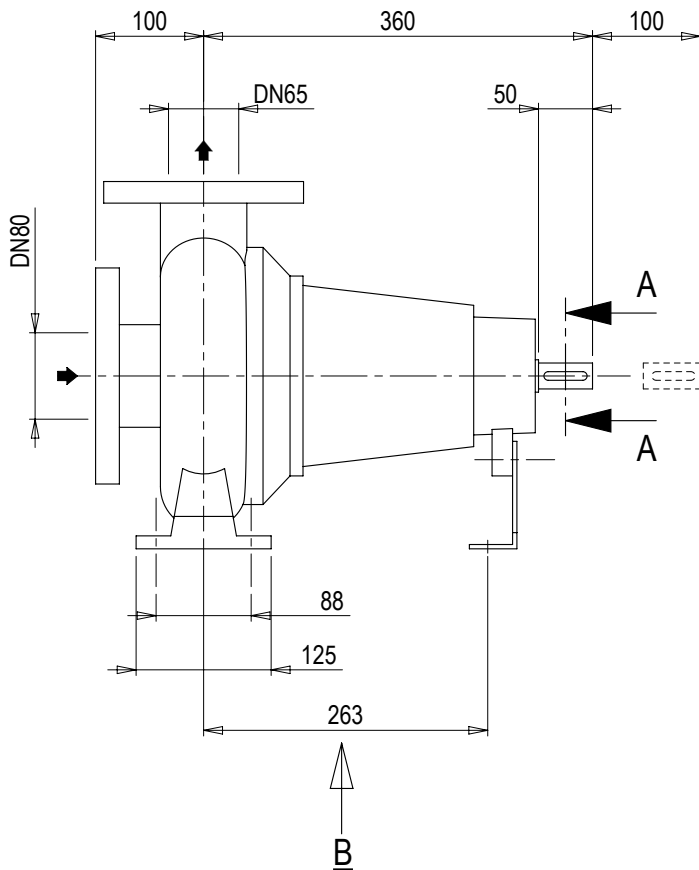
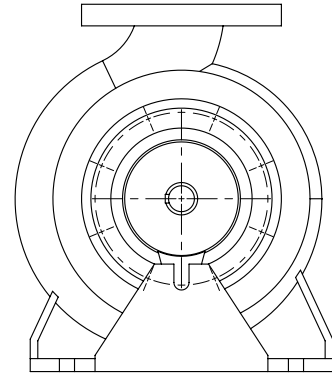
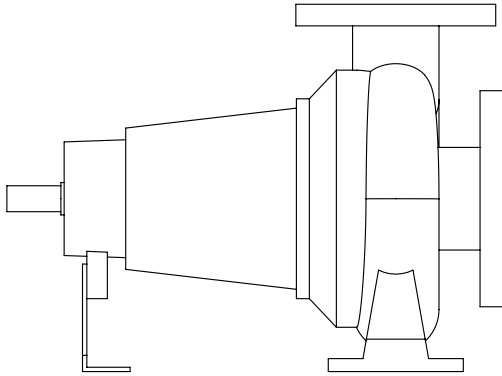
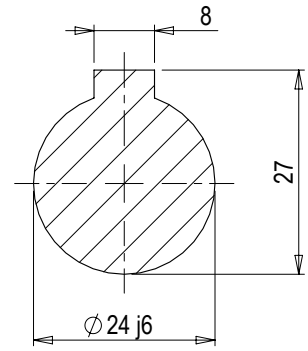

| | | | | | | |
|--------------------------------------|----------------------------|-------------------------------|----------------------|----------------------|-----------|-----------------|
| Dimensioni in mm Dimensions in mm | | Dipartimento: Department: | Z13 | N° Disegno / Drw N°: | Vers: | Foglio / Sheet: |
| Scala / Scale: 1:7 | Data / Date: 30.05.2023 | Disegnato / Drawn: DS00291 | Approvato / Checked: | 10017995 | 00 | 1/1 |