

VISTA B

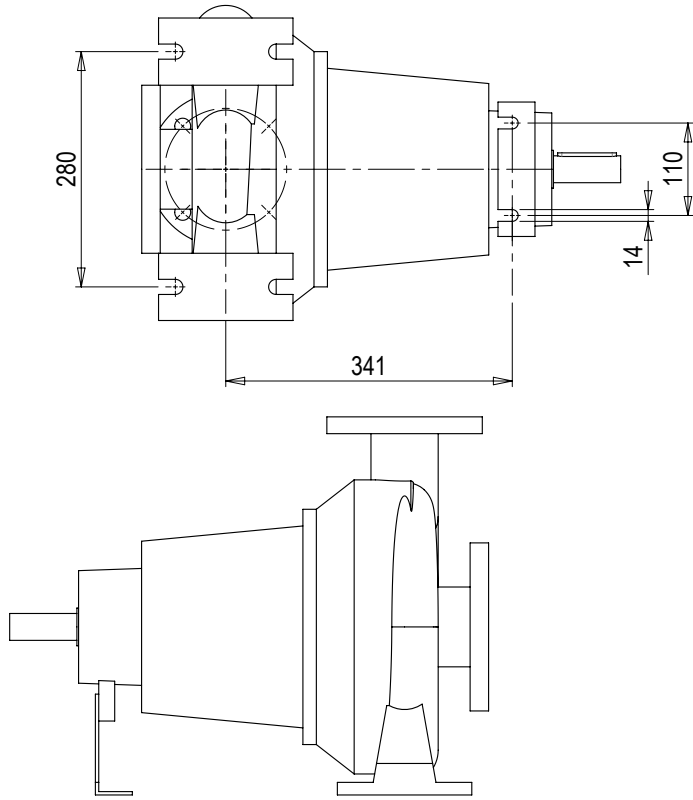

SEZ. A-A
SCALA: 1:1

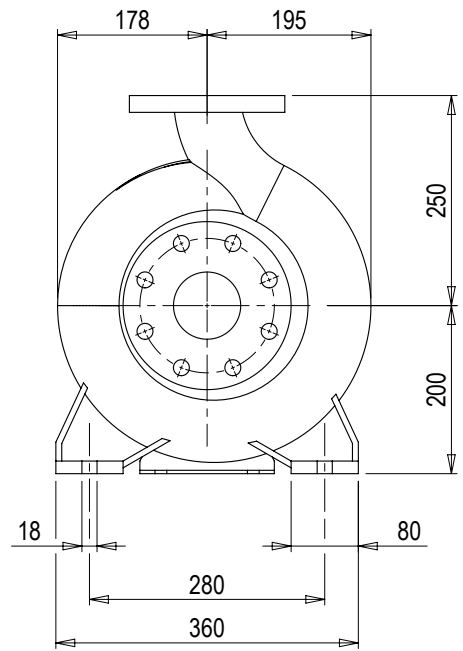
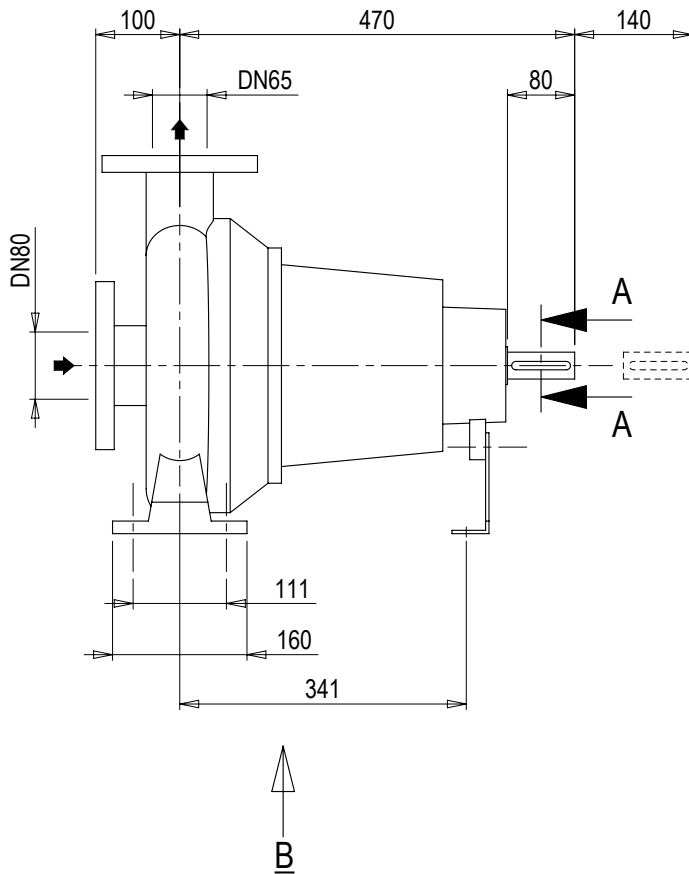
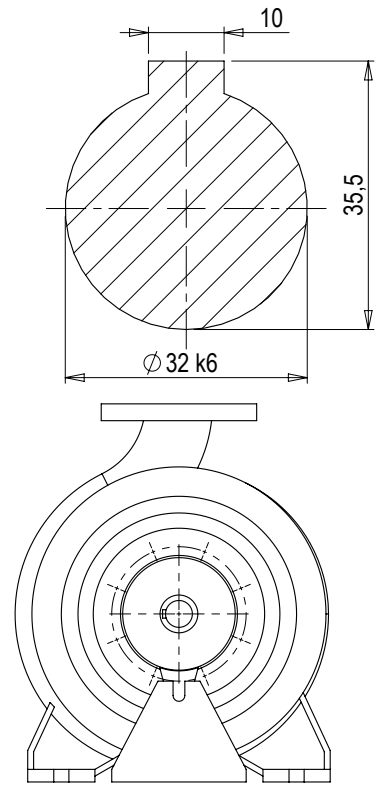

Dimensioni in mm Dimensions in mm		Dipartimento: Department:	Z13	N° Disegno / Drw N°:	Vers:	Foglio / Sheet:
Scala / Scale: 1:9	Data / Date: 30.05.2023	Disegnato / Drawn: DS00291	Approvato / Checked:	10017998	00	1/1